

BAUX IS FOUNDED
ON THE BELIEF
THAT BUILDING
MATERIALS
SHOULD BE BOTH
SURPRISINGLY
FUNCTIONAL AND
REMARKABLY
BEAUTIFUL.

LET'S BUILD!

PRODUCTS



Wood wool is a functional, natural material.

BAUX Acoustic Wood Wool is made from two of the world's oldest building materials, wood and cement.

The combination is simple and ingenious. Wood fibre offers excellent insulation, heat retention and sound absorption. Cement, a proven and popular building material, is the binder that provides strength, moisture resistance and fire protection. Therefore, BAUX Acoustic products are versatile and durable in all climates.

ACOUSTIC TILES

SQUARE

Large: 2.97 tiles per m²
Small: 11.9 tiles per m²
25 mm thick



RECTANGLE

Large: 1.49 tiles per m²
Small: 5.95 tiles per m²
25 mm thick



CIRCLE

Large: 3.78 tiles per m²
Small: 15.1 tiles per m²
25 mm thick



TRIANGLE

Large: 5.95 tiles per m²
Small: 23.8 tiles per m²
25 mm thick

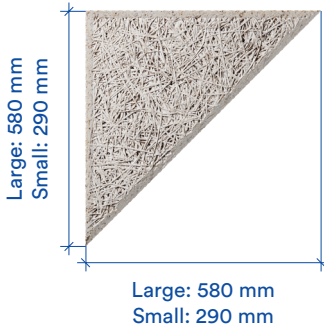

PLANK

NATURALLY COLOURED

Large: 2.97 tiles per m²
Small: 11.9 tiles per m²
25 mm thick



PARALLELOGRAM

Large: 2.97 tiles per m²
Small: 11.9 tiles per m²
25 mm thick



HEXAGON

Large: 4.45 tiles per m²
Small: 17.8 tiles per m²
25 mm thick

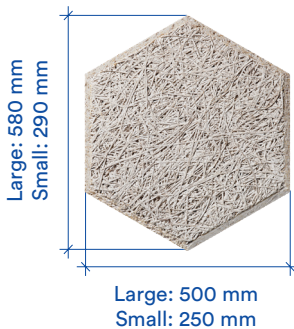

ACOUSTIC PANELS

QUILT

1.49 tiles per m²
25 mm thick



STRIPES

1.49 tiles per m²
25 mm thick



DIAGONAL

1.49 tiles per m²
25 mm thick

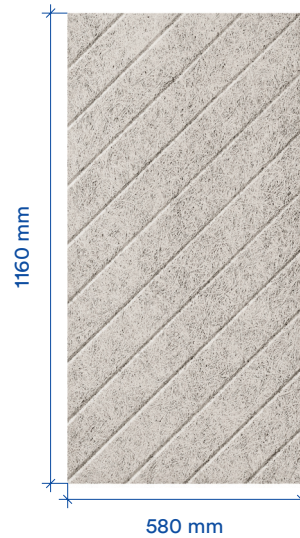

LINES

1.49 tiles per m²
25 mm thick



CHECK

1.49 tiles per m²
25 mm thick



ARCH

1.49 tiles per m²
25 mm thick



CURVE

1.49 tiles per m²
25 mm thick



3D PIXEL

11.9 tiles per m²



70

70 mm thick

50

50 mm thick

25

25 mm thick

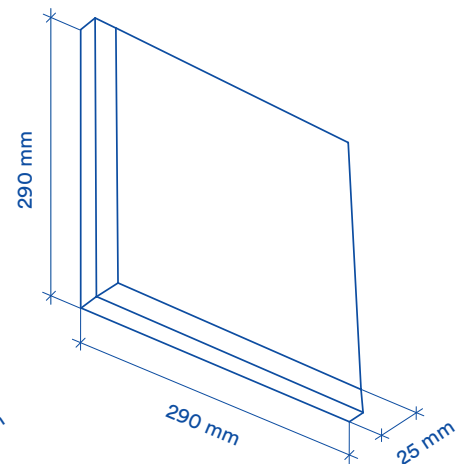
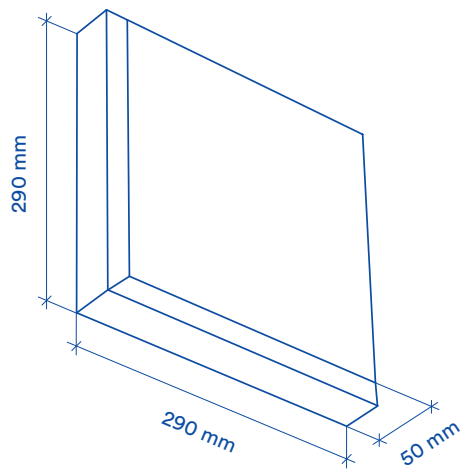
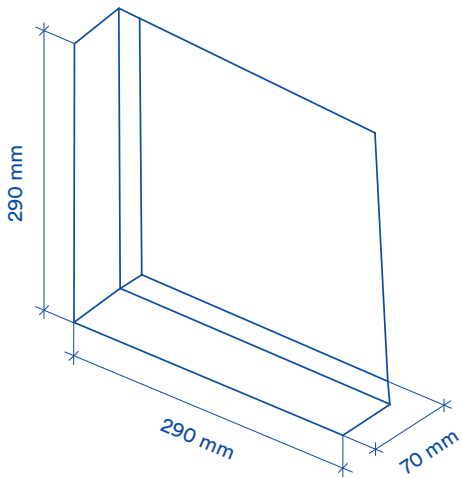



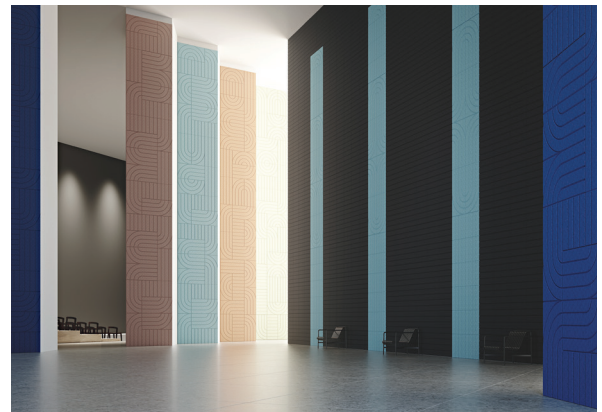

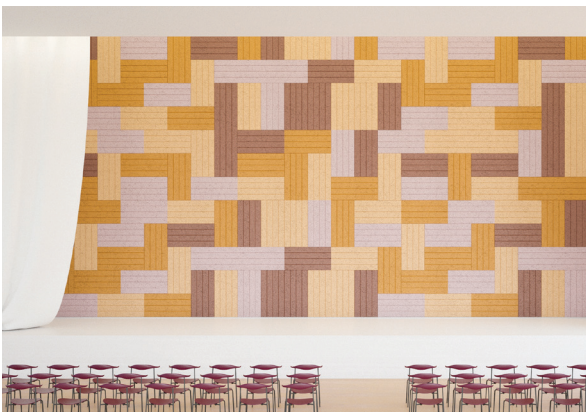

BAUX PATTERNS



BAUX Patterns makes it simpler than ever to transform any space with a unique BAUX design. Browse through our Pattern collections and choose from over 500 designs. All free to download!

Each pattern is designed to repeat like wallpaper so you can quickly calculate how many tiles you need for your wall or space. All patterns include 3d architectural files.

Browse the full patterns library on www.baux.se/patterns.

COLOUR SCHEME

CLOUDS

WOODS

SKY IN THE SEA

HEAT OF THE SUN

EARTH AND MOUNTAIN

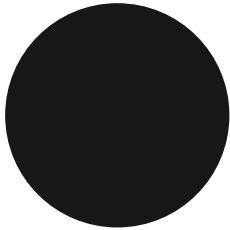

NCS 9000-N

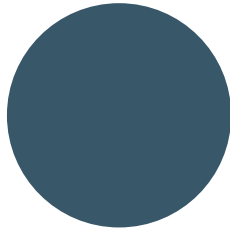

NCS S 6020-B

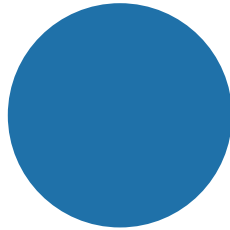

NCS S 3050-R90B

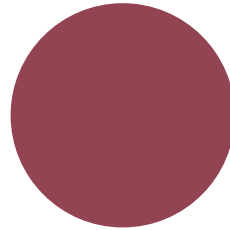

NCS S 4040-R10B

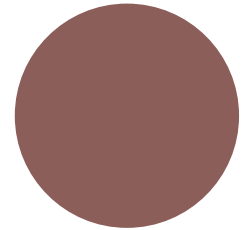

NCS S 5020-Y90R

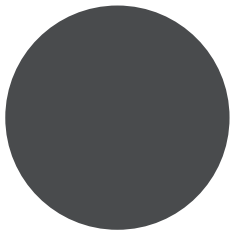

NCS S 7502-B

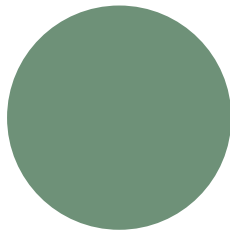

NCS S 4020-G10Y

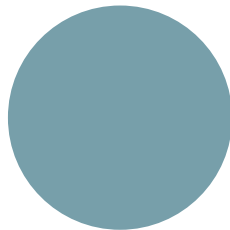

NCS S 3020-B10G

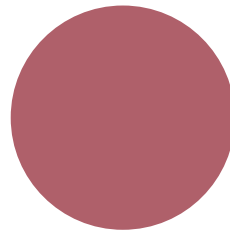

NCS 3040-R10B

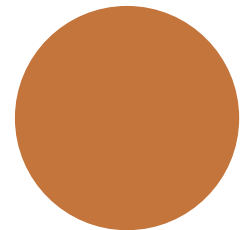

NCS 3050-Y40R

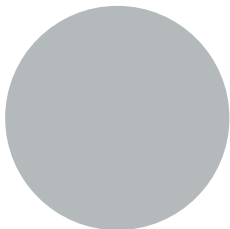

NCS S 2502-B

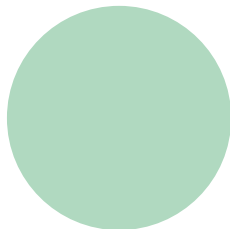

NCS S 1020-G

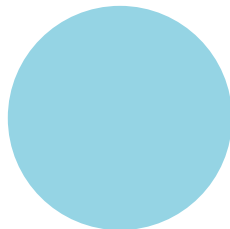

NCS S 0530-B10G

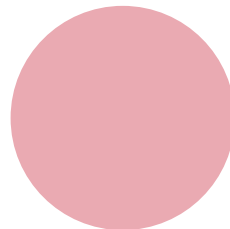

NCS S 1030-R10B

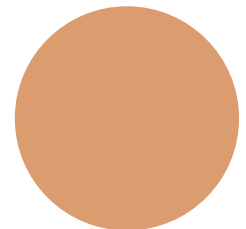

NCS S 2030-Y40R

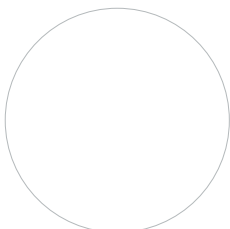

NCS S 0300-N

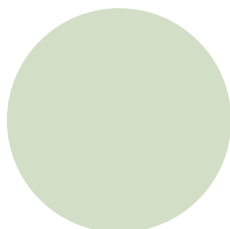

NCS S 1010-G30Y

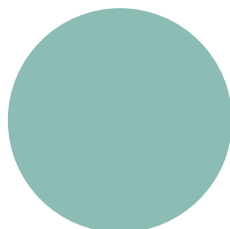

NCS S 2020-B70G

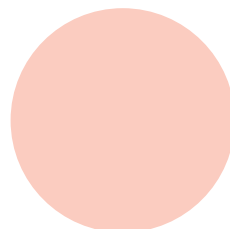

NCS S 0520-Y80R

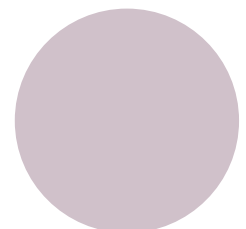

NCS S 1510-R40B

SOUND

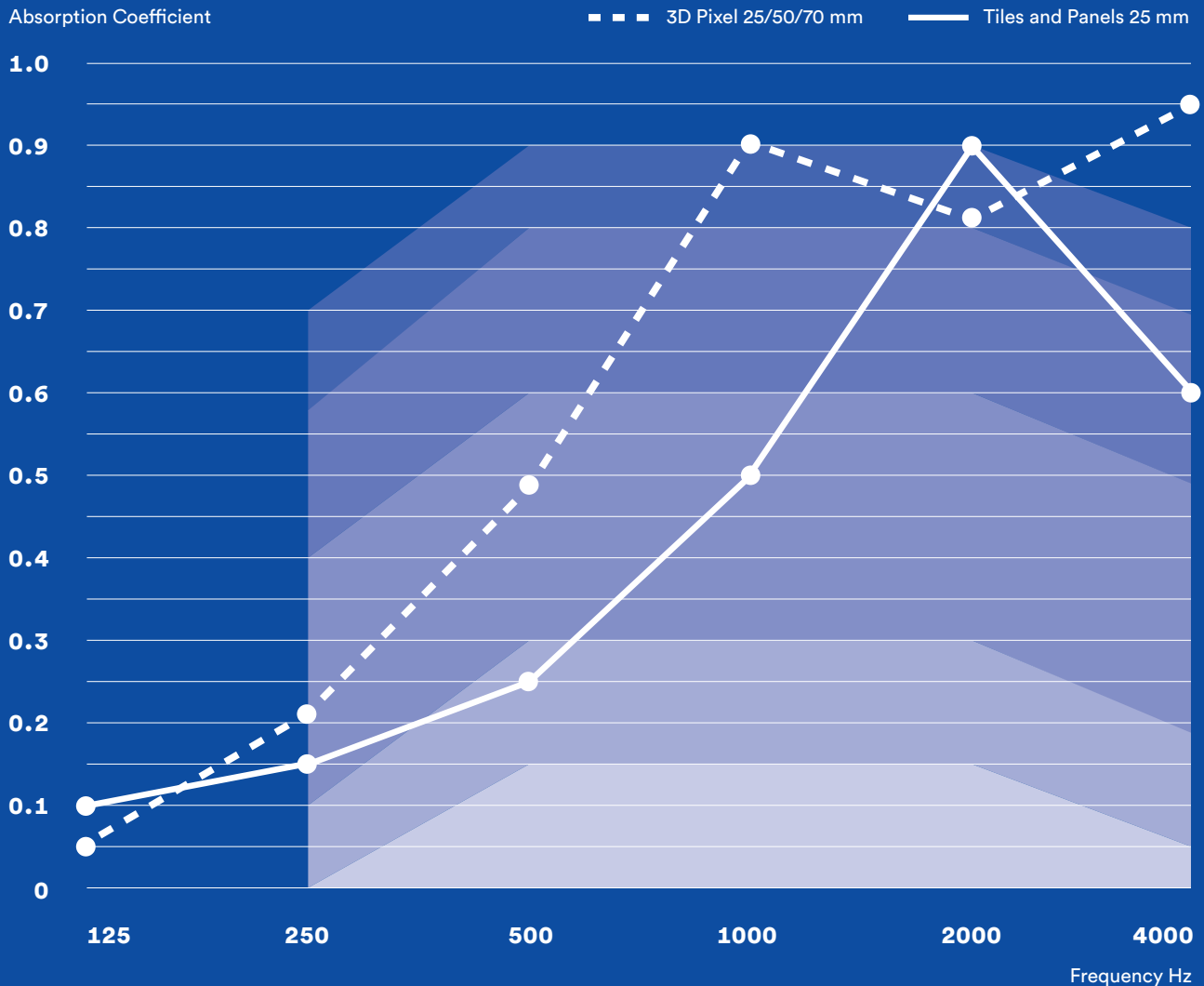

This graph shows the practical absorption coefficient of BAUX Acoustic Wood Wool at any given audio frequency.

The material structure of BAUX Acoustic products reduces sound reflections, making it a great sound absorber. The material dampens noise and contributes to restful acoustics in residential buildings, industrial premises and public spaces.

INFO@BAUX.SE
WWW.BAUX.SE

BAUX