



Horizon™

● Horizon™ Rectangle
in Acros, Flatiron and Savoye

● Exeter University,
United Kingdom



Give your ceiling a silver lining

Horizon™ is a range of floating acoustic panels that create a cloud-like illusion when suspended. With clean lines and simple, two-dimensional geometric forms, Horizon elegantly holds space as both a design feature and a high-performance acoustic absorber.

Made from 100% polyester fibre, Horizon panels are lightweight yet strong; easily installed on ceilings and walls without the need for clear space, as the channels, clips, and suspension wires require limited contact. The adjustable suspension system allows you to set the hanging height with ease, giving you the ability to target multiple frequency levels within the space. Horizon can also be clipped to walls as a removable acoustic panel, without the need for adhesives.

To find out more about Horizon
visit www.autexglobal.com



Features and benefits

- Delivers excellent acoustic performance
- Suitable for wall and ceiling applications
- Low VOC—beneficial for IEQ
- UV resistant qualities
- No formaldehyde, crystalline silica, or other carcinogens
- Easy to remove and clean
- Hides ceiling services
- Durable, providing long-term stability and performance

Applications

- Decorative and functional acoustic treatment for interior spaces

Panel Fixing System Patent

US Patent 10,113,312 | AU Patent 2016250499 |
GB Patent 2,545,789 | NZ Patent app 725770



Design options

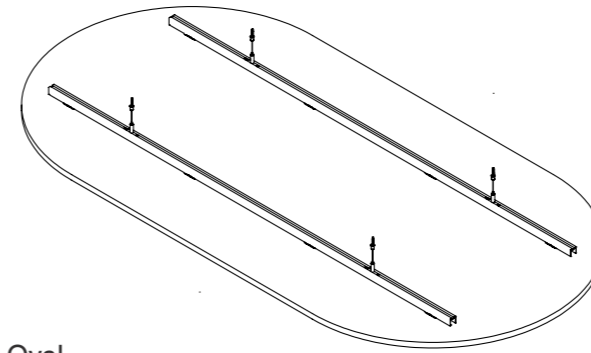

Oval

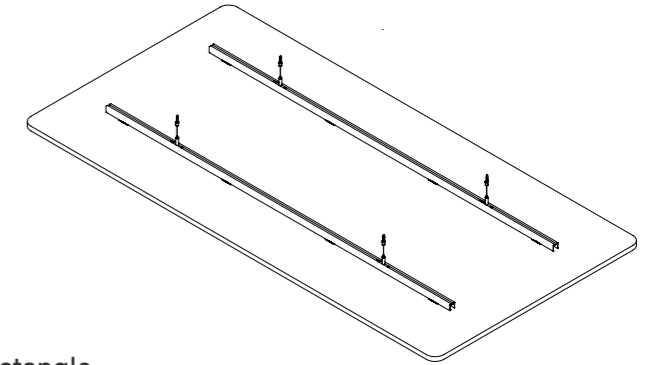

Rectangle

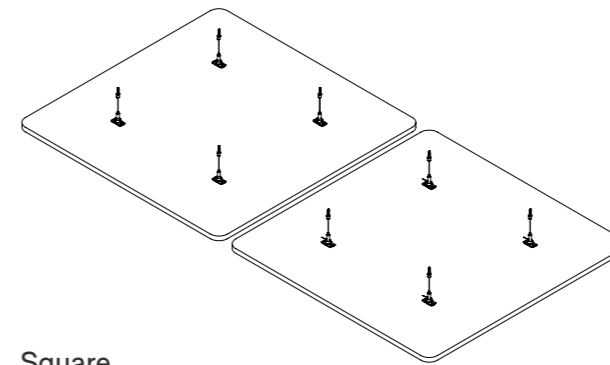

Square

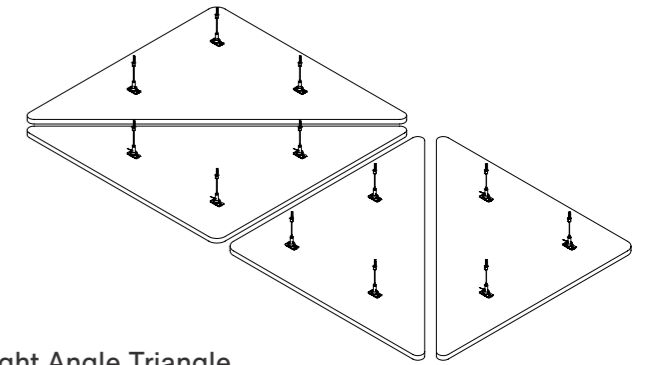

Right Angle Triangle

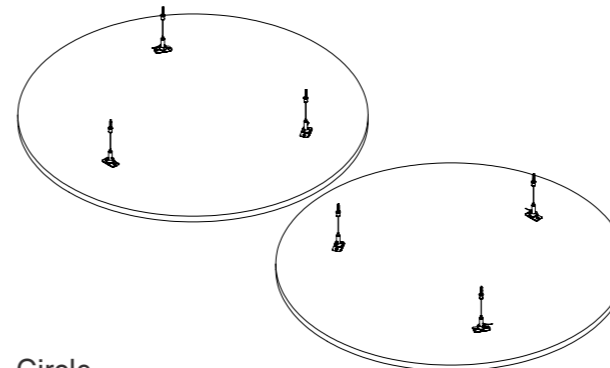

Circle

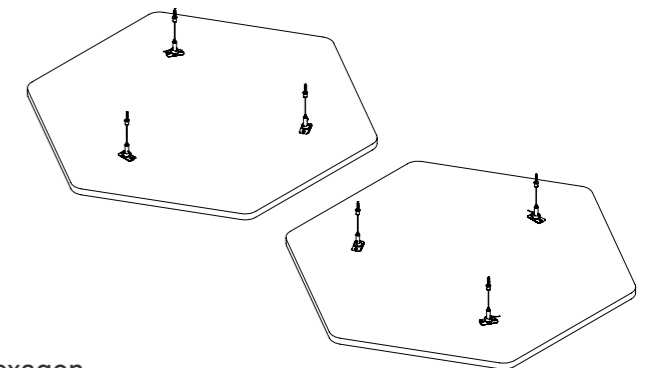

Hexagon

Colour options

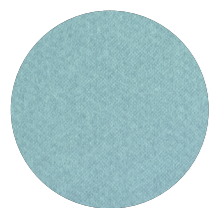

Falling Water

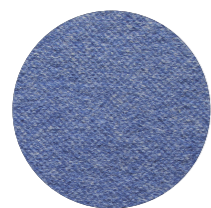

Galaxy

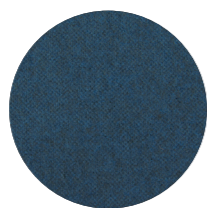

Pinnacle

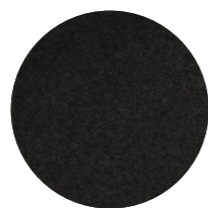

Petronas

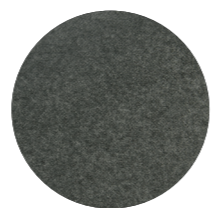

Empire



Flatiron



Savoye

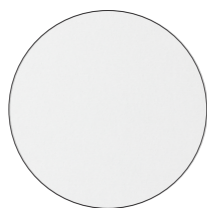

Pavilion

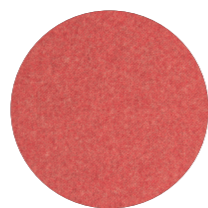

Ironbank

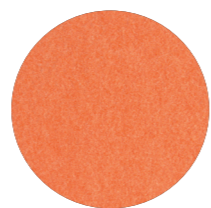

Zenith

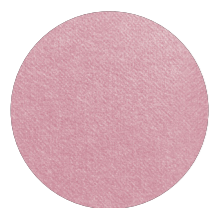

Rosada



Opera



Senado

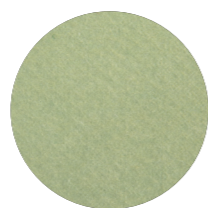

Acros

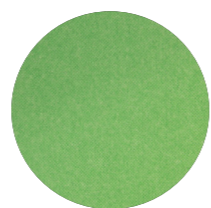

Bosco



Lotus



Tree House



Gherkin

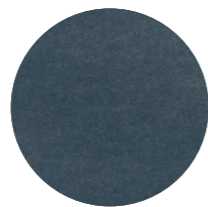

Muralla

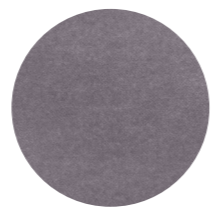

Cavalier

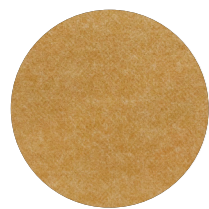

Beehive

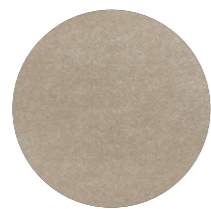

Parthenon



Sargazo



● Autex Acoustics, New Zealand

● Horizon in Falling Water



Customisation

As creators and innovators, we understand your pursuit of the bold and unusual, the rare and exceptional—the brave, colour-outside-the-lines ideas. Every space you design is unique, therefore, every element—from floor to ceiling—should be tailored to fit. Our customisation tools offer unique avenues for creative expression to help you achieve your vision—all that's left to explore are the boundaries of your imagination.

Our customisation capabilities include Print, Etch™, Groove, Precision Cut, Mould and Press, and Peel 'n' Stick.



● Custom Horizon in Petronas, Ironbank and Pavilion

● Designgroup Stapleton Elliot, New Zealand



Caring for the environment

Horizon is manufactured using 100% polyester fibre and contains a minimum of 60% recycled fibre (from PET plastics). Our products are designed to be recycled at the end of their life too.

We have continual improvement programmes in which we implement a range of initiatives to mitigate the environmental 'hotspots' that we have identified. Our products are GreenRate Level A, Health Product Declaration (HPD), and CDHP Standard certified.

Horizon is made from Cube which is DeclareSM certified to be Red List free and can be used in Living Building Challenge projects. Autex has a high functioning Environmental Management System (ISO 14001) to enhance our environmental performance and contribute to sustainable development.



Declare.



● **Autex Industries Ltd**

702-718 Rosebank Rd
Private Bag 19988
Avondale 1746, Auckland
New Zealand
Freephone 0800 428 839
Phone +64 9 828 9179
Fax +64 9 828 5810

● **Autex Australia Pty Ltd**

166 Bamfield Road
PO Box 5099
West Heidelberg, Melbourne
VIC 3081, Australia
Freephone 1800 678 160
Phone +61 3 9457 6700
Fax +61 3 9457 1020

● **Autex Acoustics Ltd**

Unit J4, Lowfields Way,
Lowfields Business Park,
Elland, West Yorkshire
Hx5 9Da
United Kingdom
Phone +44 0 1422418899

● **Autex Acoustics LLC**

1630 Dan Kipper Dr,
Riverside, CA 92507
United States of America
Phone +1 424 203 1813

An ISO 9001, ISO 14001 and ISO 45001 certified company. The brand names and logos mentioned herein are registered or unregistered trademarks either owned or used under license by Autex Industries Limited or other members of the Autex Group. The contents of this document are protected by Copyright 2021 Autex Industries Ltd. All Rights Reserved. It is the user's responsibility to determine if the product and information presented in this document is suitable for the intended application by engaging a suitably qualified consultant. The information contained in this document is correct to the best of our knowledge at the date of its publication. To verify that this document is the most current publication please check our website or contact your Autex account manager.