



CORKBEE

info@corkbee.com

www.corkbee.com



CORKBEE

Polish brand focused on good design,
high quality and sustainability.
Polska marka stawiająca na dobry design,
wysoką jakość i zrównoważony rozwój.

CORKWALL

Collection of 3D wall panels made of natural cork.
Kolekcja paneli ściennych 3D
wykonanych z naturalnego korka.



Cork is renewable, recyclable and biodegradable.
Korek jest odnawialny, biodegradowalny,
nadaje się do recyklingu



Corkbee panels take care of the acoustics and
microclimate of the interior.
Panele Corkbee zadbają o akustykę
i mikroklimat wnętrza.



Environmentally friendly product
Produkt przyjazny środowisku



Available in 11 standard colors
with the possibility of custom colors
Dostępne w 11 standardowych kolorach
z możliwością wykonania kolorów na zamówienie



Corkbee panels have many arrangement possibilities,
creating unique final effects on the wall.
Panele Corkbee mają wiele możliwości ułożenia,
tworząc unikalne efekty końcowe na ścianie.



The panels are light.
They can also be mounted on the ceiling.
Panele są lekkie.
Mogą być montowane również na suficie.



Antistatic material.
Materiał antystatyczny.



The panels are easy to install.
Panele są łatwe w montażu



Corkbee panels can be fire-retardant impregnated
and receive a certificate C-s2, d0 (EN 13501-1 :2018)
Panele Corkbee mogą zostać zaimpregnowane przeciwogniowo
z certyfikatem C-s2,d0 (EN 13501-1 :2018)

POSSIBILITIES OF INSTALLATION (EXAMPLES)
 PRZYKŁADOWE MOŻLIWOŚCI MONTAŻU

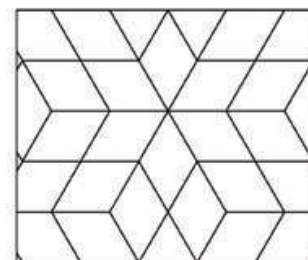
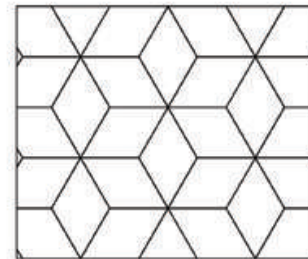
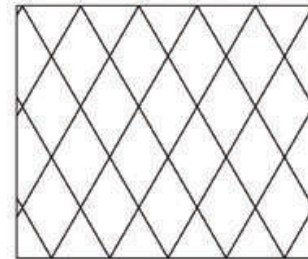
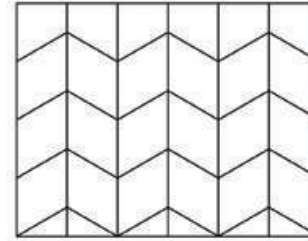

STRIPE

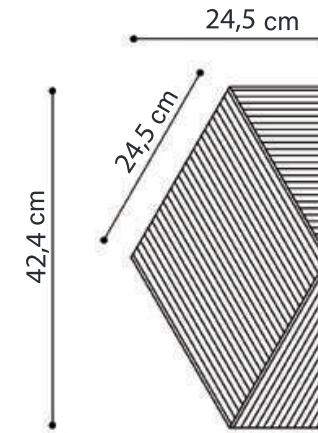

CORKWALL PANELS: Agglomerated cork produced using compression moulding technology
 PANELE CORKWALL: Korek aglomerowany formowany pod ciśnieniem

PACKING: 3 pieces
 PAKOWANIE: 3 sztuki

PANELS IN 1 M2: 19
 LICZBA PANELI W 1 M2: 19

WEIGHT: 230 g Natural/ 250 g Colour
 WAGA: 230 g Natural / 250 g Kolor

THICKNESS: 5 mm - 10 mm
 GRUBOŚĆ: 5 mm - 10 mm

COLOURS
 KOLORY



IVORY



NATURAL

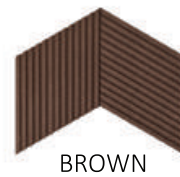

BROWN

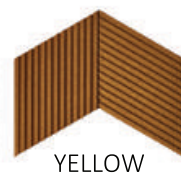

YELLOW



GREY

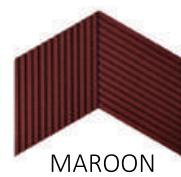

MAROON

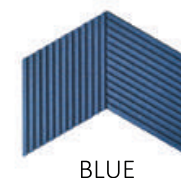

BLUE



DEEP BLUE



DARK GREEN



GREEN



BLACK

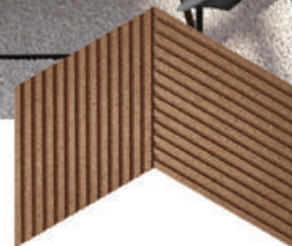

NATURAL





NATURAL

POSSIBILITIES OF INSTALLATION (EXAMPLES)
PRZYKŁADOWE MOŻLIWOŚCI MONTAŻU

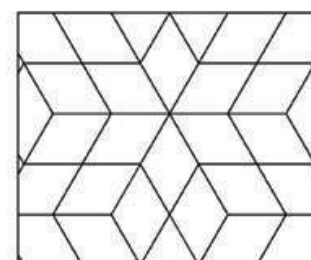
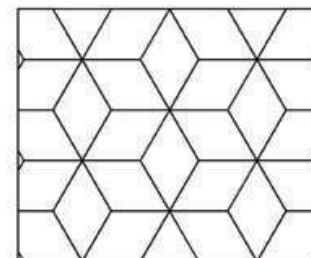
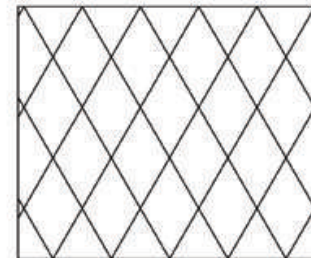
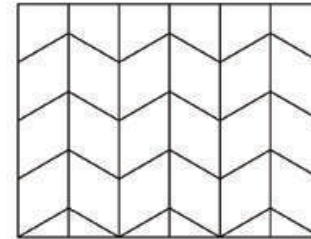

LINE

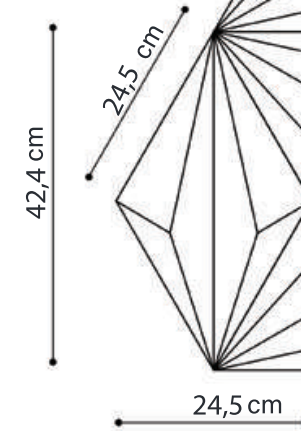

CORKWALL PANELS: Agglomerated cork produced using compression moulding technology

PANELE CORKWALL: Korek aglomerowany formowany pod ciśnieniem

PACKING: 3 pieces

PAKOWANIE: 3 sztuki

PANELS IN 1 M2: 19

LICZBA PANELI W 1 M2: 19

WEIGHT: 230 g Natural/ 250 g Colour

WAGA: 230 g Natural/ 250 g Kolor

THICKNESS: 5 mm - 30 mm

GRUBOŚĆ: 5 mm - 30 mm

COLOURS
KOLORY



IVORY



NATURAL



BROWN



YELLOW



GREY

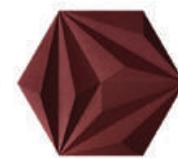

MAROON



BLUE

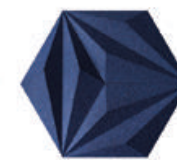

DEEP BLUE



DARK GREEN



GREEN



BLACK

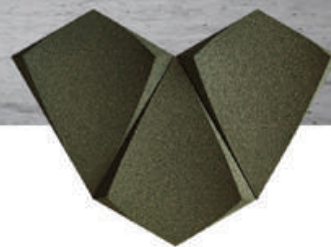

DARK GREEN

POSSIBILITIES OF INSTALLATION (EXAMPLES)
PRZYKŁADOWE MOŻLIWOŚCI MONTAŻU

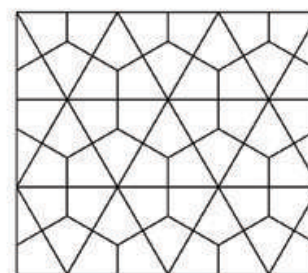
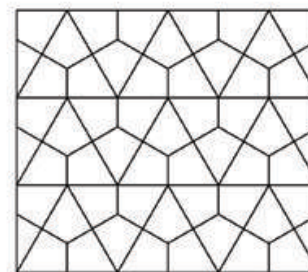
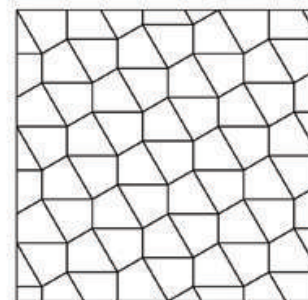
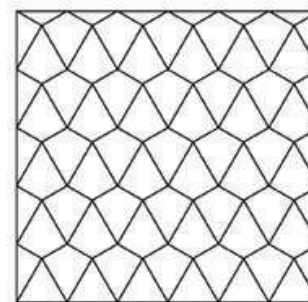

CORKWALL PANELS: Agglomerated cork produced using compression moulding technology

PANELE CORKWALL: Korek aglomerowany formowany pod ciśnieniem

PACKING: 6 pieces
PAKOWANIE: 6 sztuki

PANELS IN 1 M2: 40
LICZBA PANELI W 1 M2: 40

WEIGHT:
150 g Natural/ 180 g Color
WAGA: 150 g Natural/ 180 g Kolor

THICKNESS:
20 mm - 30 mm
GRUBOŚĆ: 20 mm - 30 mm

KITE

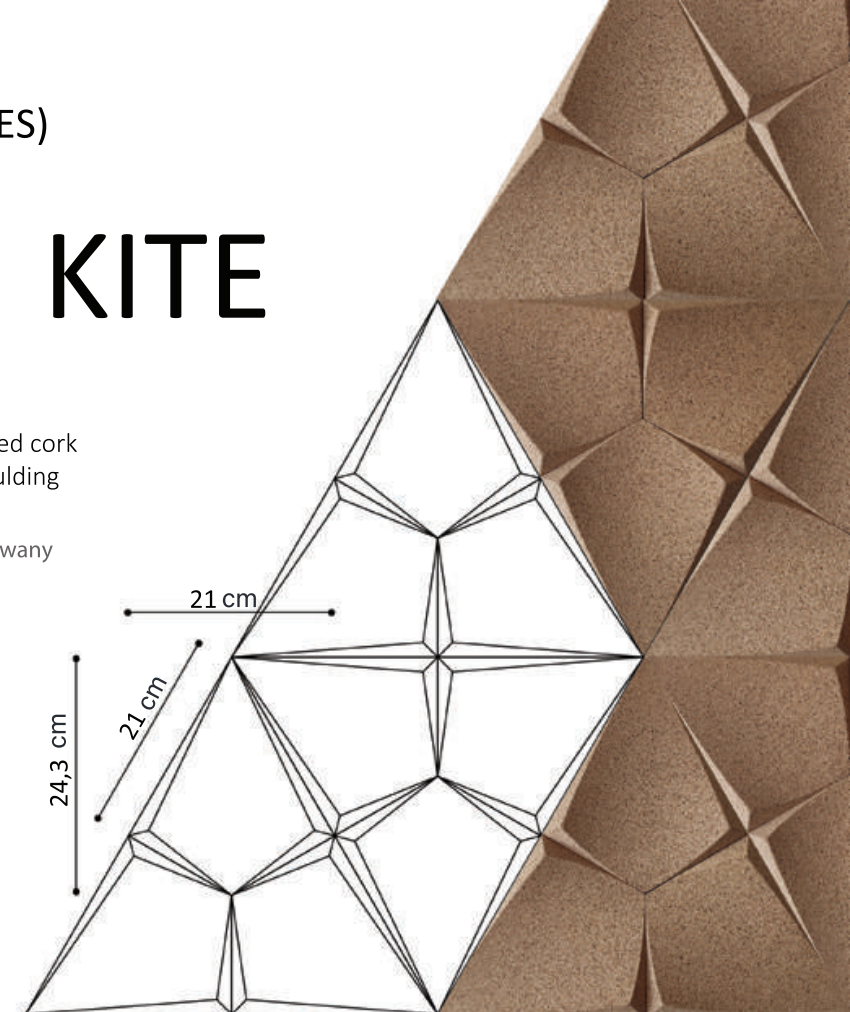

COLOURS
KOLORY





GREY

POSSIBILITIES OF INSTALLATION (EXAMPLES)
 PRZYKŁADOWE MOŻLIWOŚCI MONTAŻU

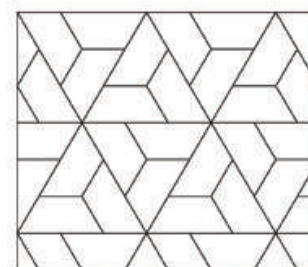
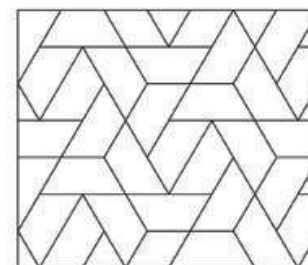
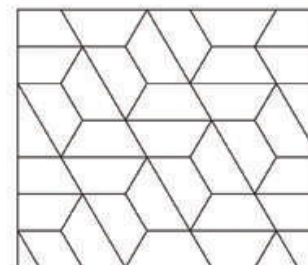
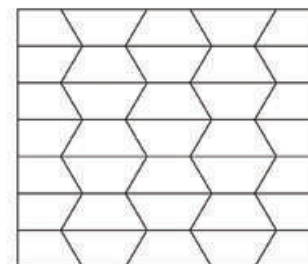

WEAVE

CORKWALL PANELS: Agglomerated cork produced using compression moulding technology
 PANELE CORKWALL: Korek aglomerowany formowany pod ciśnieniem

PACKING: 9 pieces
 PAKOWANIE: 9 sztuki

PANELS IN 1 M2: 25
 LICZBA PANELI W 1 M2: 25

WEIGHT: 150 g Natural/ 180 g Colour
 WAGA: 150 g Natural/ 180 g Kolor

THICKNESS: 5 mm - 15 mm
 GRUBOŚĆ: 5 mm - 15 mm

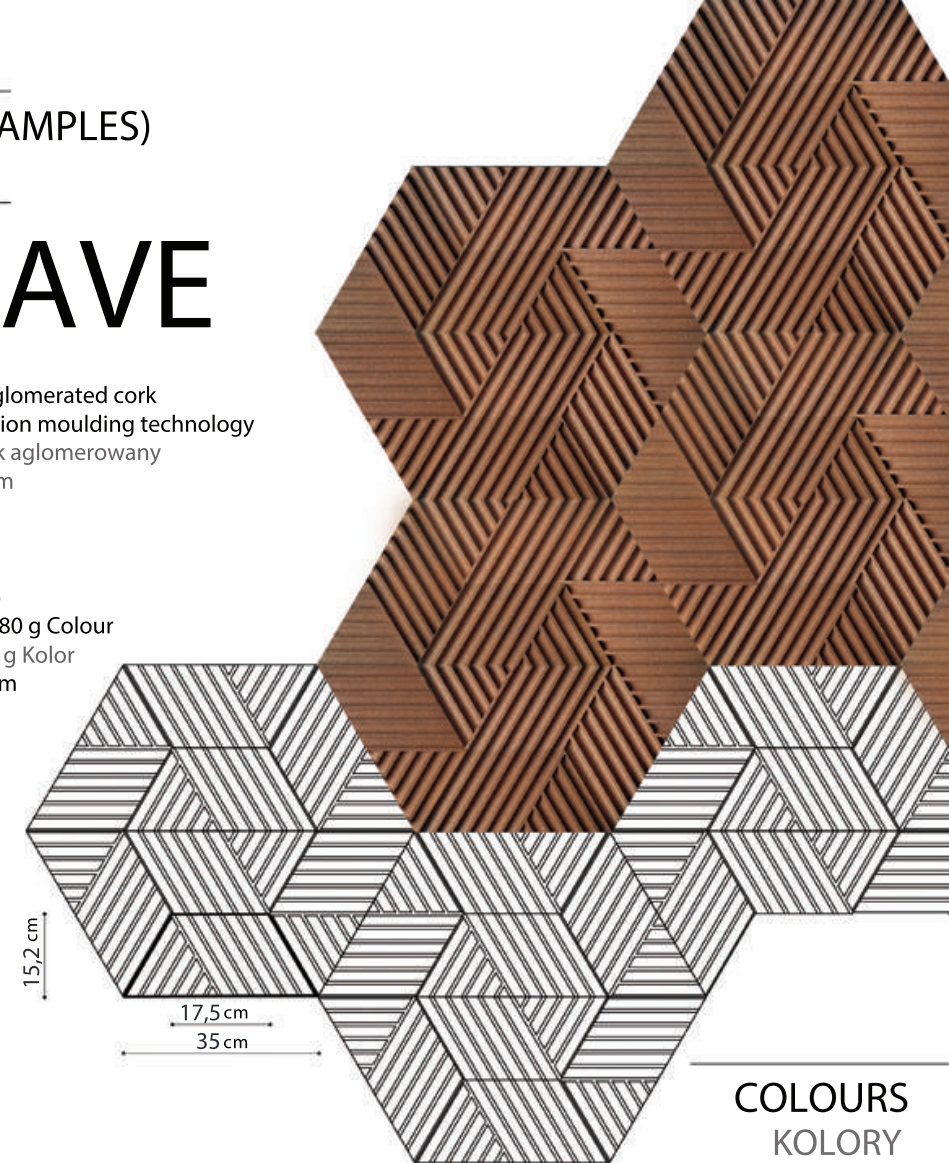

COLOURS
 KOLORY



IVORY



NATURAL



BROWN



YELLOW



GREY



MAROON



BLUE



DEEP BLUE



DARK GREN



GREEN



BLACK

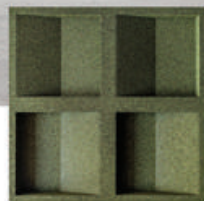

GREEN

POSSIBILITIES OF INSTALLATION (EXAMPLES)
 PRZYKŁADOWE MOŻLIWOŚCI MONTAŻU

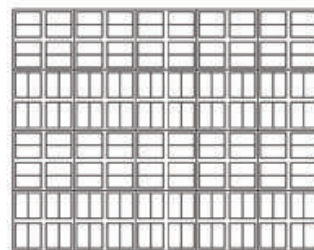
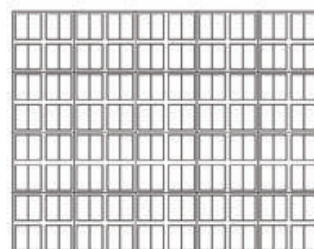
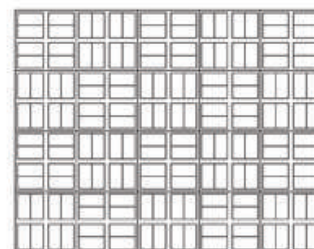
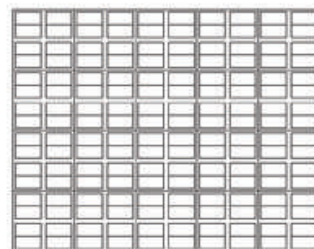

CONCAVE

CORKWALL PANELS: Agglomerated cork produced using compression moulding technology
 PANELE CORKWALL: Korek aglomerowany formowany pod ciśnieniem
PACKING: 4 pieces
 PAKOWANIE: 4 sztuki
PANELS IN 1 M2: 16
 LICZBA PANELI W 1 M2: 16
WEIGHT: 300 g Natural/ 340 g Colour
 WAGA: 300 g Natural/ 340 g Kolor
THICKNESS: 25 mm
 GRUBOŚĆ: 25 mm

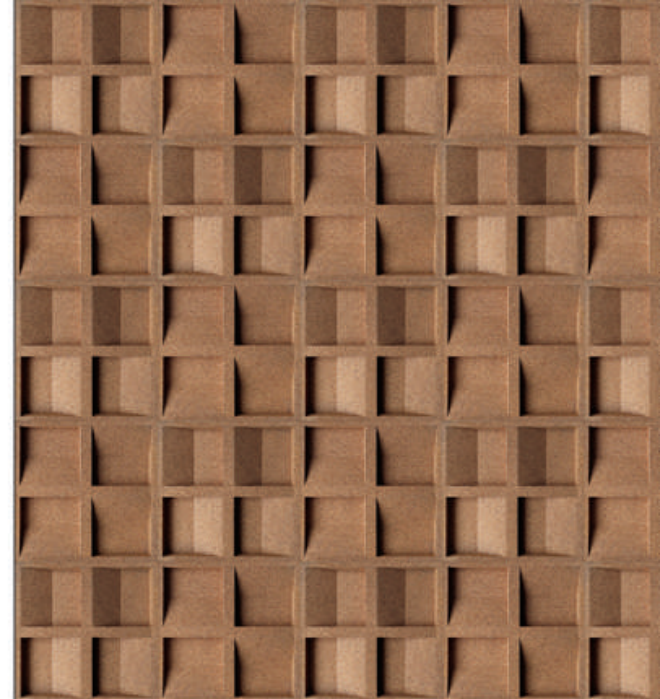

25 cm

25 cm

COLOURS
 KOLORY



IVORY



NATURAL



BROWN



YELLOW



GREY



MAROON



BLUE



DEEP BLUE



DARK GREN



GREEN



BLACK

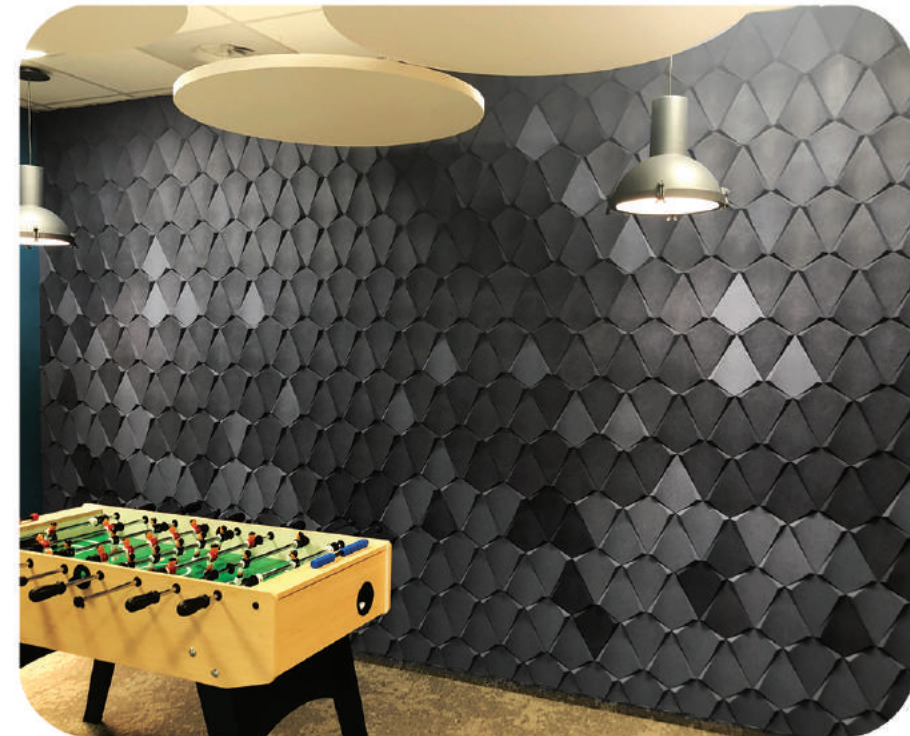
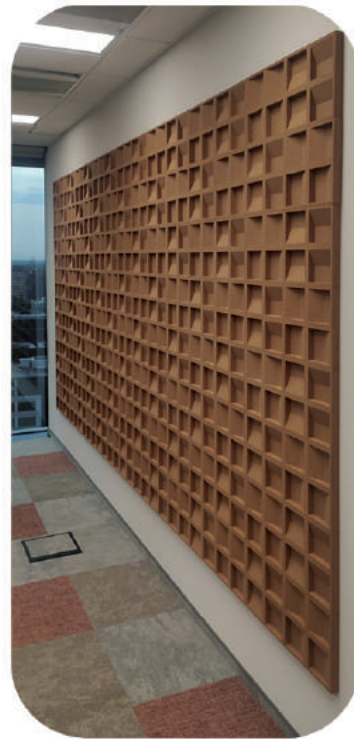
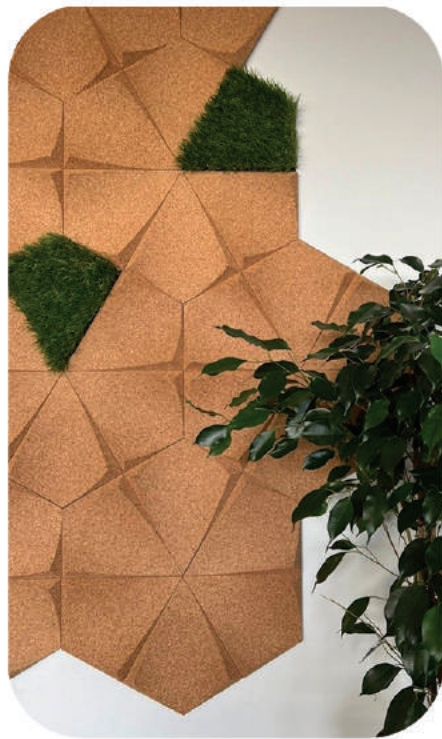

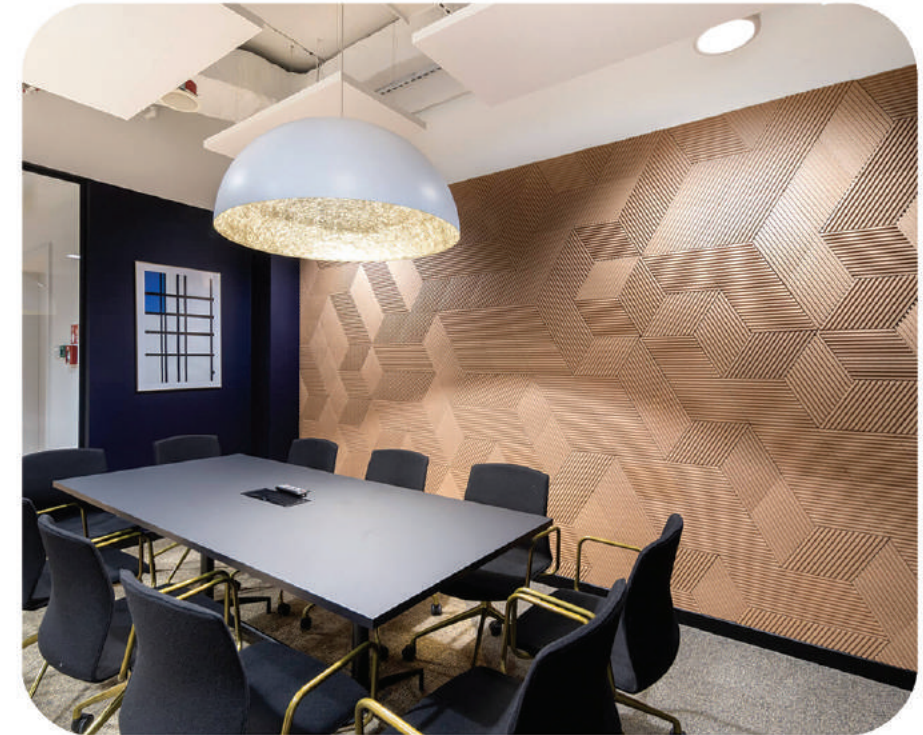
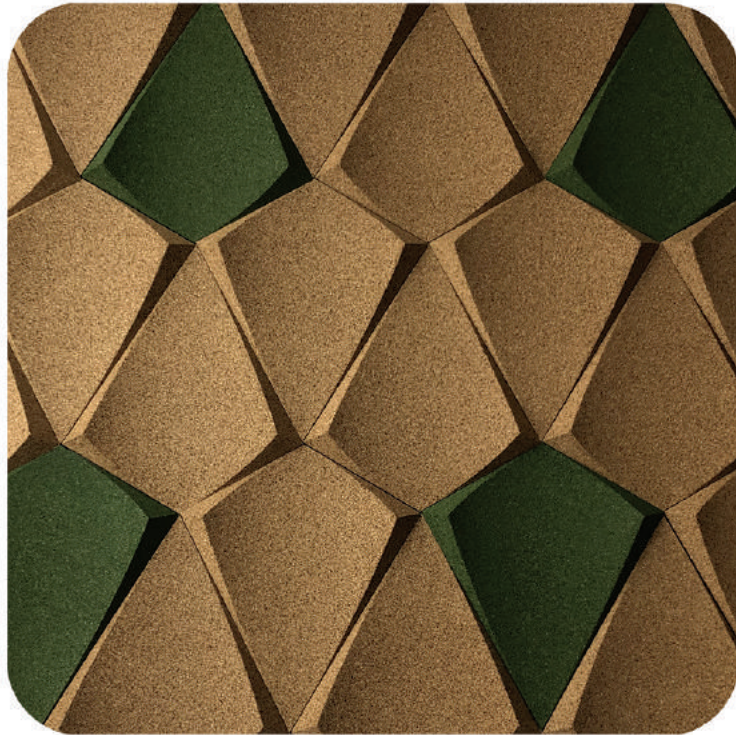
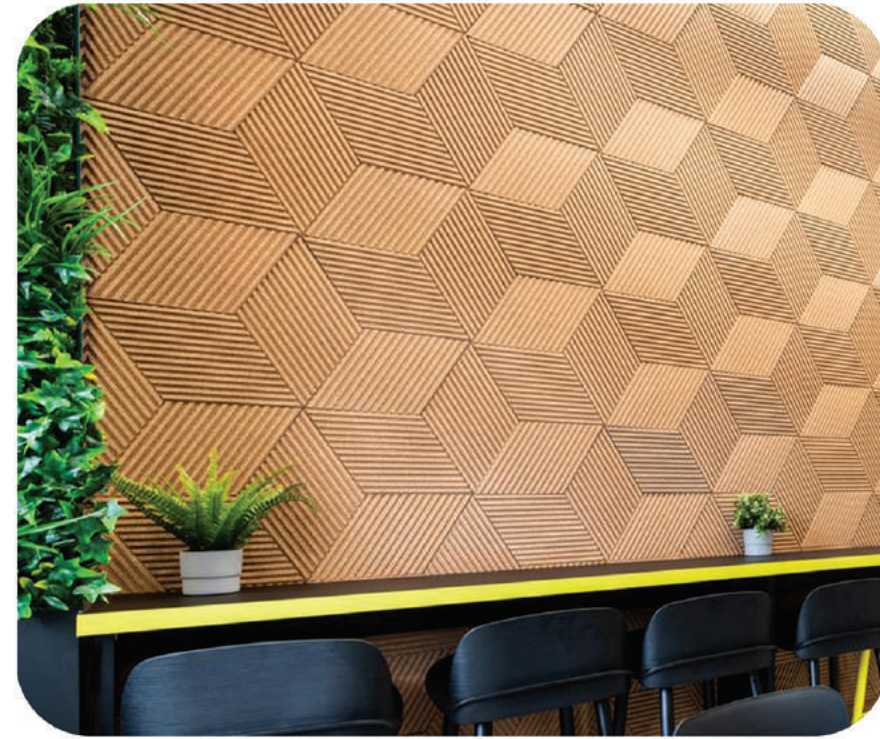

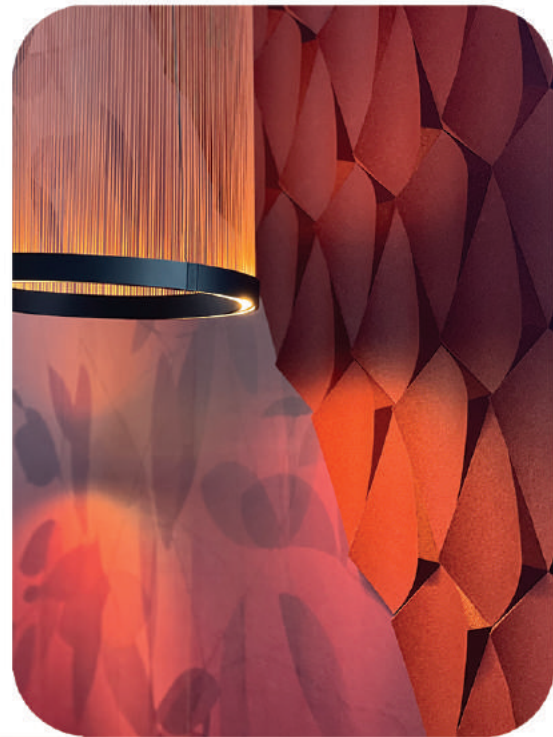
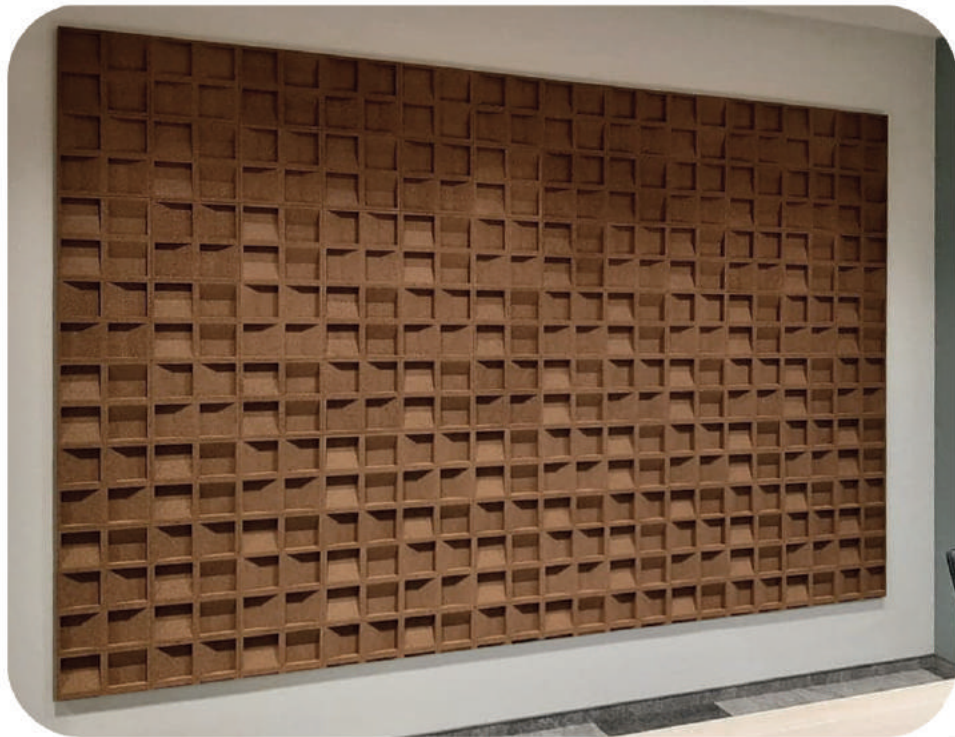



CORKBEE

info@corkbee.com

www.corkbee.com